

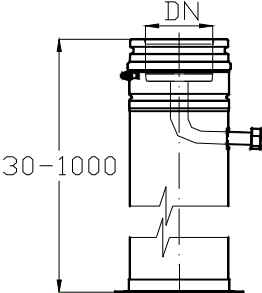

Technické listy tříložkového komínového systému  
**ICS25**

## Obsah technických listů systému ICS25

Název dílu	Kód výrobku	Stránka
Dno s podpěrou	83711 XXX 84	3
Dno s odvodem kondenzátu	81111 XXX 84	
Díl vynášecí a dilatační	81211 XXX 84	
Dno bez desky	83611 XXX 84	
Uzávěr ICS25	84111 XXX 84	
Dvířkový díl	81311 XXX 84	4
Komínový díl s kontrolním otvorem	81411 XXX 84	
Sopouch 0°	81511 XXX 84	
Sopouch 5°	81611 XXX 84	
Sopouch 45°	81711 XXX 84	5
Sopouch LAS 60	83411 XXX 84	
Sopouch LAS 80	83311 XXX 84	
Rovný díl 0,955m	81811 XXX 84	
Rovný díl 0,455m	81911 XXX 84	6
Rovný díl 0,205m	82011 XXX 84	
Rovný díl 0,155m	84311 XXX 84	
Nastavitelný díl	82911 XXX 84	
Přechodový díl z PPL na ICS25	83211 XXX 84	
Přechodový díl z ICS25 na PPL	83811 XXX 84	7
Koleno 15°	82211 XXX 84	
Koleno 30°	82311 XXX 84	
Koleno 45°	82411 XXX 84	
Koleno 85°	82511 XXX 84	
Koleno 85° s kontrolním otvorem	82621 XXX 84	8
Koleno 90°	82711 XXX 84	
Koleno 90° s kontrolním otvorem	82821 XXX 84	
Díl s odvodem kondenzátu	83011 XXX 84	
Díl pro měření	83111 XXX 84	9
Kónická hlavice	82111 XXX 84	
Krokový držák	84611 XXX 84	
Kotvící objímka	87611 XXX 84	
Statická spona	87411 XXX 84	
Rozeta DW	84811 XXX 84	
Prostup střechou 0°	40010 XXX 74	10
Prostup střechou 3° - 15°	40020 XXX 74	
Prostup střechou 16° - 25°	40030 XXX 74	
Prostup střechou 26° - 35°	40040 XXX 74	
Prostup střechou 36° - 45°	40050 XXX 74	11
Patní konzole	87011 XXX 91	12
Nástěnná konzole	87911 XXX 91	
Přestavitelné lůžko na konzoli	87811 XXX 91	
Pevné lůžko	87211 XXX 91	

<b>Dno s podpěrou</b>		DN mm	80	100	130	150	180	200
	kg/kus	3,015	3,666	4,462	5,013	5,852	6,432	
	DN mm	230	250	300	350	400		
	kg/kus	7,383	7,947	9,425	10,730	11,725		

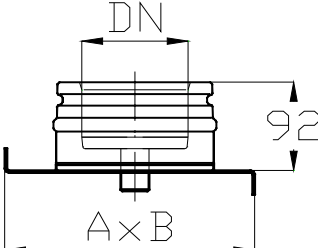
<b>Dno s odvodem</b>		DN mm	80	100	130	150	180	200
	kondenzátu	kg/kus	2,051	2,568	3,190	3,639	4,352	4,863
	A (mm)	220	220	240	240	270	290	
	B (mm)	250	250	270	270	300	320	
	DN mm	230	250	300	350	400		
	kg/kus	5,731	6,262	7,791	9,349	10,752		
	A (mm)	320	340	370	390	445		
	B (mm)	350	370	400	420	475		

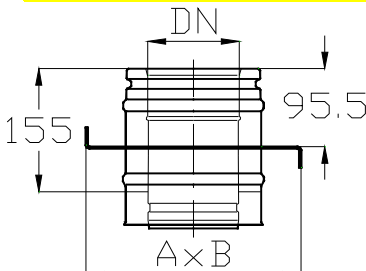
<b>Díl vynášecí a dilatační</b>		DN mm	80	100	130	150	180	200
	kg/kus	1,749	2,018	2,426	2,702	3,120	3,403	
	A (mm)	220	220	240	240	270	290	
	B (mm)	250	250	270	270	300	320	
	DN mm	230	250	300	350	400		
	kg/kus	3,836	4,122	4,925	6,101	7,353		
	A (mm)	320	340	370	390	445		
	B (mm)	350	370	400	420	475		

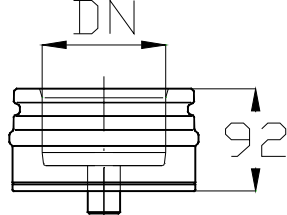
<b>Dno bez desky</b>		DN mm	80	100	130	150	180	200
	kg/kus	1,009	1,355	1,697	1,944	2,329	2,605	
	DN mm	230	250	300	350	400		
	kg/kus	3,098	3,362	4,092	4,697	5,085		

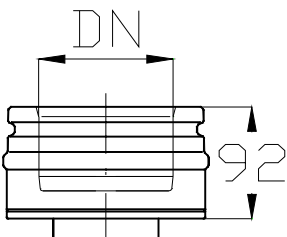
<b>Uzávěr ICS</b>		DN mm	80	100	130	150	180	200
	kg/kus	0,058	0,069	0,104	0,096	0,112	0,123	
	DN mm	230	250	300	350	400		
	kg/kus	0,140	0,150	0,175	0,204	0,231		

<b>Dvířkový díl</b>	<b>DN mm</b>	<b>80</b>	<b>100</b>	<b>130</b>	<b>150</b>	<b>180</b>	<b>200</b>
	kg/kus			4,521	4,767	5,267	5,576
<b>DN mm</b>	<b>230</b>	<b>250</b>	<b>300</b>	<b>350</b>	<b>400</b>		
kg/kus	6,077	6,415	7,231	8,078	8,939		

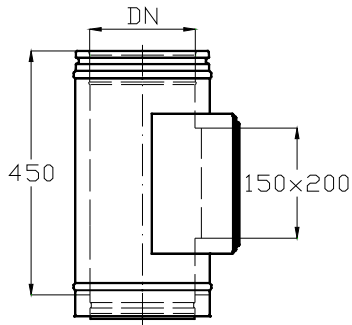

<b>Komínový díl s kontrolním otvorem</b>	<b>DN mm</b>	<b>80</b>	<b>100</b>	<b>130</b>	<b>150</b>	<b>180</b>	<b>200</b>
	kg/kus	1,571	1,881	3,340	3,633	4,148	4,504
	A (mm)	288	288	455	455	455	455
<b>DN mm</b>	<b>230</b>	<b>250</b>	<b>300</b>	<b>350</b>	<b>400</b>		
kg/kus	5,100	5,448	6,314	7,228	8,133		
A (mm)	455	455	455	455	455		

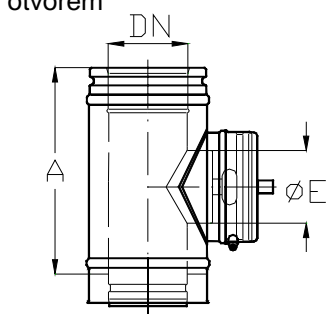

<b>Sopouch 0°</b>	<b>DN mm</b>	<b>80</b>	<b>100</b>	<b>130</b>	<b>150</b>	<b>180</b>	<b>200</b>
	kg/kus	1,627	1,947	3,419	3,876	4,567	5,035
	A (mm)	288	288	455	455	455	455
	B (mm)	121	121	205	205	205	205
<b>DN mm</b>	<b>230</b>	<b>250</b>	<b>300</b>	<b>350</b>	<b>400</b>		
kg/kus	6,035	6,557	7,897	10,391	12,811		
A (mm)	455	455	455	530	580		
B (mm)	205	205	212	243	267		

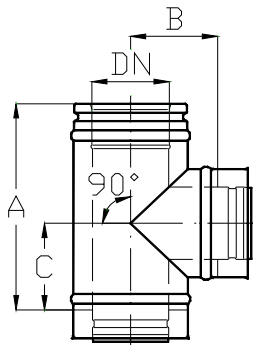

<b>Sopouch 5°</b>	<b>DN mm</b>	<b>80</b>	<b>100</b>	<b>130</b>	<b>150</b>	<b>180</b>	<b>200</b>
	kg/kus	1,627	1,947	3,419	3,876	4,567	5,035
	A (mm)	288	288	455	455	455	455
	B (mm)	125	126	211	212	213	214
<b>DN mm</b>	<b>230</b>	<b>250</b>	<b>300</b>	<b>350</b>	<b>400</b>		
kg/kus	6,035	6,557	7,897	10,391	12,811		
A (mm)	455	455	455	530	580		
B (mm)	215	220	234	260	295		

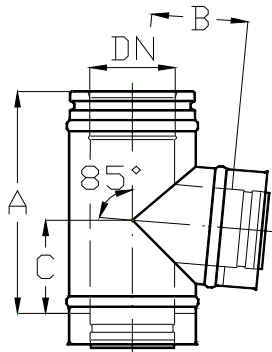

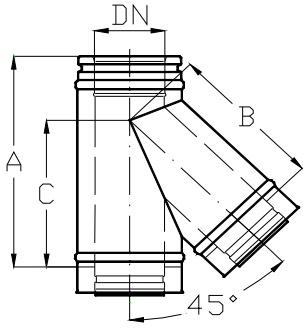
<b>Sopouch 45°</b>		DN mm	80	100	130	150	180	200
	kg/kus	1,847	2,472	4,109	4,633	5,371	6,801	
	A (mm)	288	330	455	455	455	530	
	B (mm)	240	270	368	368	358	416	
	C (mm)	200	230	328	328	318	378	
	<b>DN mm</b>	<b>230</b>	<b>250</b>	<b>300</b>	<b>350</b>	<b>400</b>		
	kg/kus	7,786	8,609	11,527	14,775	18,394		
A (mm)	530	545	623	693	763			
B (mm)	430	443	509	569	630			
C (mm)	390	403	469	529	590			

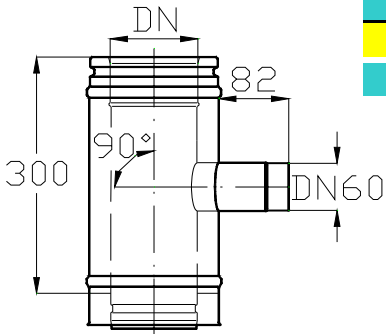
<b>Sopouch LAS 60</b>		DN mm	80	100	130	150	180	200
	kg/kus		1,911	2,072	2,315	2,652	2,901	
	<b>DN mm</b>	<b>230</b>	<b>250</b>	<b>300</b>	<b>350</b>	<b>400</b>		
	kg/kus	3,222	3,511	4,123	4,692	5,174		

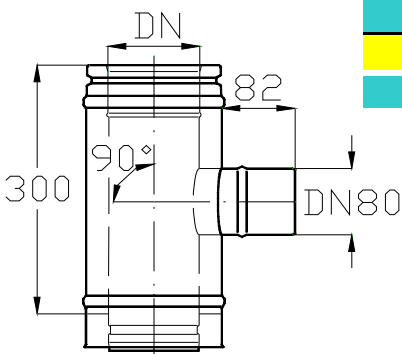
<b>Sopouch LAS 80</b>		DN mm	80	100	130	150	180	200
	kg/kus		1,909	2,070	2,313	2,649	2,898	
	<b>DN mm</b>	<b>230</b>	<b>250</b>	<b>300</b>	<b>350</b>	<b>400</b>		
	kg/kus	3,219	3,507	4,119	4,687	5,169		

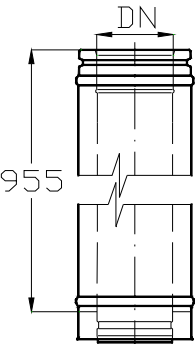
<b>Rovný díl 0,955m</b>		DN mm	80	100	130	150	180	200
	kg/kus	3,986	4,729	5,837	6,580	7,688	8,430	
	<b>DN mm</b>	<b>230</b>	<b>250</b>	<b>300</b>	<b>350</b>	<b>400</b>		
	kg/kus	9,560	10,281	12,081	13,959	15,810		

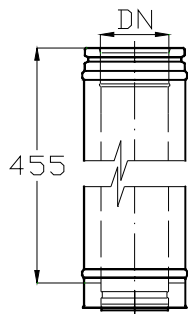
**Rovný díl 0,455m**

DN mm	80	100	130	150	180	200
kg/kus	1,975	2,341	2,889	3,256	3,803	4,170
DN mm	230	250	300	350	400	
kg/kus	4,728	5,085	5,974	6,902	7,816	

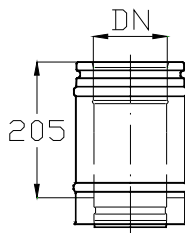
**Rovný díl 0,205m**

DN mm	80	100	130	150	180	200
kg/kus	0,969	1,148	1,415	1,594	1,861	2,040
DN mm	230	250	300	350	400	
kg/kus	2,312	2,486	2,921	3,373	3,819	

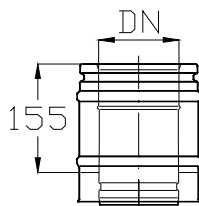
**Rovný díl 0,155m**

DN mm	80	100	130	150	180	200
kg/kus	0,768	0,909	1,120	1,262	1,473	1,614
DN mm	230	250	300	350	400	
kg/kus	1,829	1,967	2,310	2,667	3,019	

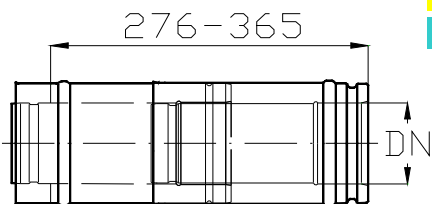
**Nastavitelný díl**

DN mm	80	100	130	150	180	200
kg/kus	1,857	2,200	2,718	3,061	3,572	3,915
DN mm	230	250	300	350	400	
kg/kus	4,435	4,770	5,609	6,481	7,335	

**Přechodový díl**

z PPL na ICS25

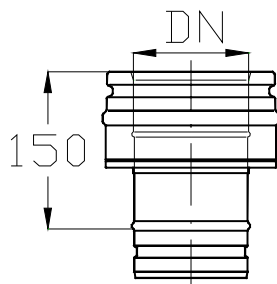

DN mm	80	100	130	150	180	200
kg/kus	0,473	0,568	0,710	0,805	0,947	1,042
DN mm	230	250	300	350	400	
kg/kus	1,186	1,279	1,511	1,768	2,051	

<b>Přechodový díl</b>	<b>DN mm</b>	<b>80</b>	<b>100</b>	<b>130</b>	<b>150</b>	<b>180</b>	<b>200</b>
z ICS25 na PPL	kg/kus	0,473	0,568	0,710	0,805	0,947	1,042
	<b>DN mm</b>	<b>230</b>	<b>250</b>	<b>300</b>	<b>350</b>	<b>400</b>	
	kg/kus	1,186	1,279	1,511	1,718	1,880	

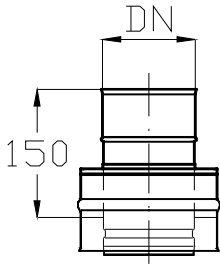

<b>Koleno 15°</b>	<b>DN mm</b>	<b>80</b>	<b>100</b>	<b>130</b>	<b>150</b>	<b>180</b>	<b>200</b>
	kg/kus	0,739	0,877	1,084	1,221	1,428	1,566
	A (mm)	57	57	57	57	57	57
	B (mm)	92	92	92	92	92	92
	<b>DN mm</b>	<b>230</b>	<b>250</b>	<b>300</b>	<b>350</b>	<b>400</b>	
	kg/kus	1,776	1,911	2,247	2,869	3,250	
	A (mm)	57	57	57	67	67	
	B (mm)	92	92	92	102	102	

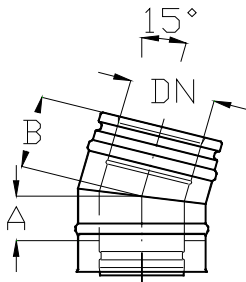

<b>Koleno 30°</b>	<b>DN mm</b>	<b>80</b>	<b>100</b>	<b>130</b>	<b>150</b>	<b>180</b>	<b>200</b>
	kg/kus	0,739	0,877	1,083	1,223	1,805	1,980
	A (mm)	57	57	57	57	82	82
	B (mm)	92	92	92	92	117	117
	<b>DN mm</b>	<b>230</b>	<b>250</b>	<b>300</b>	<b>350</b>	<b>400</b>	
	kg/kus	2,245	2,415	2,839	4,417	5,004	
	A (mm)	82	82	82	123	123	
	B (mm)	117	117	117	159	159	

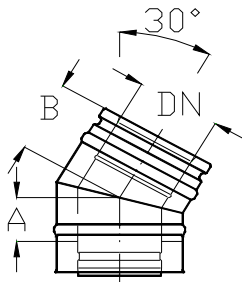

<b>Koleno 45°</b>	<b>DN mm</b>	<b>80</b>	<b>100</b>	<b>130</b>	<b>150</b>	<b>180</b>	<b>200</b>
	kg/kus	0,934	1,109	1,369	1,544	1,805	2,146
	A (mm)	82	82	82	82	82	92
	B (mm)	117	117	117	117	117	127
	<b>DN mm</b>	<b>230</b>	<b>250</b>	<b>300</b>	<b>350</b>	<b>400</b>	
	kg/kus	2,527	2,819	3,825	4,417	5,004	
	A (mm)	97	102	123	123	123	
	B (mm)	132	137	159	159	159	

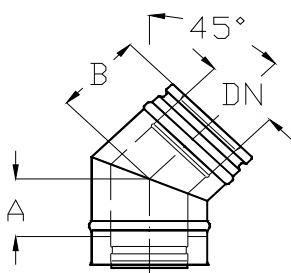

<b>Koleno 85°</b>	<b>DN mm</b>	<b>80</b>	<b>100</b>	<b>130</b>	<b>150</b>	<b>180</b>	<b>200</b>
	kg/kus	1,258	1,495	1,846	2,231	2,794	3,201
	A (mm)	138	138	139	152	166	175
	B (mm)	171	172	173	186	201	210
	<b>DN mm</b>	<b>230</b>	<b>250</b>	<b>300</b>	<b>350</b>	<b>400</b>	
	kg/kus	3,863	4,324	5,799	7,079	8,442	
	A (mm)	190	200	235	252	276	
	B (mm)	225	235	258	287	311	

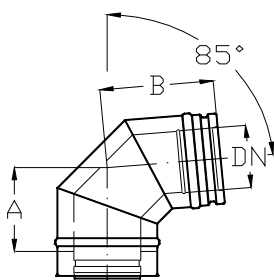

<b>Koleno 85°</b>	DN mm	80	100	130	150	180	200
s kontrolním otvorem	kg/kus	1,258	1,495	1,846	2,231	2,794	3,202
	A (mm)	138	138	139	152	166	175
	B (mm)	171	172	173	186	201	210
	DN mm	<b>230</b>	<b>250</b>	<b>300</b>	<b>350</b>	<b>400</b>	
	kg/kus	3,863	4,324	5,799	7,080	8,681	
	A (mm)	190	200	235	252	276	
	B (mm)	225	235	258	287	311	

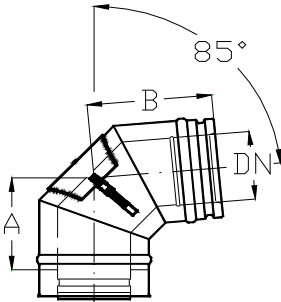

<b>Koleno 90°</b>	DN mm	80	100	130	150	180	200
	kg/kus	1,258	1,495	1,846	2,231	2,794	3,202
	A (mm)	139	139	141	154	169	179
	B (mm)	174	174	176	189	204	214
	DN mm	<b>230</b>	<b>250</b>	<b>300</b>	<b>350</b>	<b>400</b>	
	kg/kus	3,863	4,324	5,799	7,080	8,681	
	A (mm)	294	204	240	257	282	
	B (mm)	229	239	273	292	317	

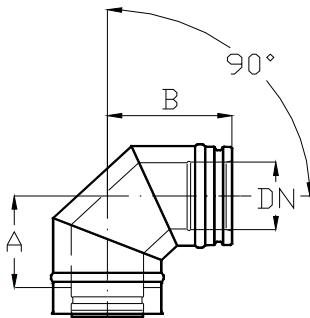

<b>Koleno 90°</b>	DN mm	80	100	130	150	180	200
s kontrolním otvorem	kg/kus	1,258	1,495	1,846	2,231	2,794	3,202
	A (mm)	139	139	141	154	169	179
	B (mm)	174	174	176	189	204	214
	DN mm	<b>230</b>	<b>250</b>	<b>300</b>	<b>350</b>	<b>400</b>	
	kg/kus	3,863	4,324	5,799	7,080	8,681	
	A (mm)	294	204	240	257	282	
	B (mm)	229	239	273	292	317	

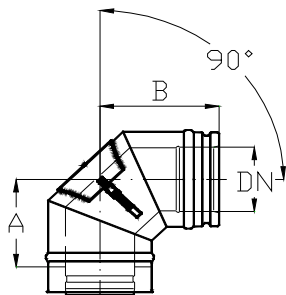

<b>Díl s odvodem kondenzátu</b>	DN mm	80	100	130	150	180	200
	kg/kus	1,029	1,215	1,490	1,675	1,952	2,137
	DN mm	<b>230</b>	<b>250</b>	<b>300</b>	<b>350</b>	<b>400</b>	
	kg/kus	2,418	2,599	3,049	3,516	3,978	

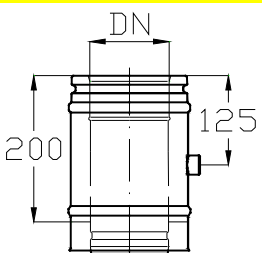

<b>Díl pro měření</b>	DN mm	80	100	130	150	180	200
	kg/kus	1,029	1,215	1,490	1,675	1,952	2,137
	DN mm	<b>230</b>	<b>250</b>	<b>300</b>	<b>350</b>	<b>400</b>	
	kg/kus	2,418	2,599	3,049	3,516	3,978	

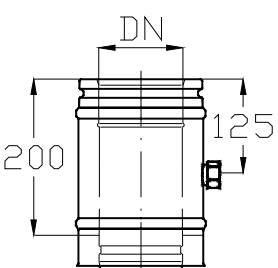



<b>Kónická hlavice</b>	DN mm	80	100	130	150	180	200
	kg/kus	0,879	1,052	1,309	1,482	1,739	1,912
	DN mm	230	250	300	350	400	
	kg/kus	2,173	2,342	2,763	3,197	3,627	

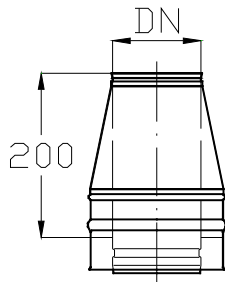

<b>Krokový držák</b>	DN mm	80	100	130	150	180	200
	kg/kus	1,00	1,10	1,22	1,25	1,30	1,33
	DN mm	230	250	300	350	400	
	kg/kus	1,240	1,400	1,470			

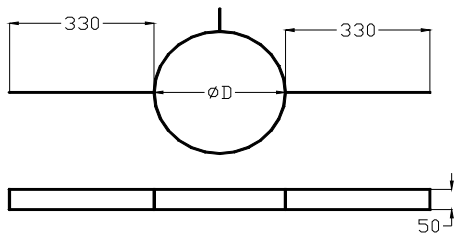

<b>Kotvící objímka</b>	DN mm	80	100	130	150	180	200
	kg/kus	0,200	0,300	0,300	0,300	0,300	0,350
	DN mm	230	250	300	350	400	
	kg/kus	0,360	0,390	0,430	0,490	0,500	

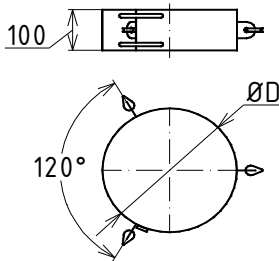

<b>Statická spona</b>	DN mm	80	100	130	150	180	200
	kg/kus	0,704	0,795	0,930	1,021	1,156	1,247
	DN mm	230	250	300	350	400	
	kg/kus	1,384	1,473	1,696	1,922	2,148	

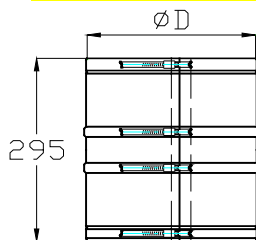

<b>Rozeta DW</b>	DN mm	80	100	130	150	180	200
	kg/kus	0,350	0,400	0,430	0,450	0,470	0,490
	Ø D(mm)	400	420	450	470	500	520
	DN mm	230	250	300	350	400	
	kg/kus	0,540	0,590				
	Ø D(mm)	570	620			-	-

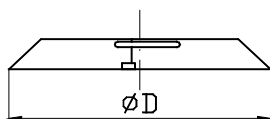

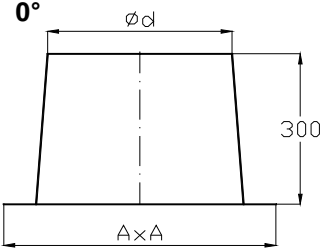
Prostup střechou		DN mm	80	100	130	150	180	200
	kg/kus	0,830	0,830	1,240	1,240	1,490	1,490	
	$\varnothing d$ (mm)	165	165	215	215	265	265	
	DN mm	230	250	300	350	400		
	kg/kus	1,770	2,100	2,460	2,990	3,210		
	$\varnothing d$ (mm)	295	320	370	415	425		

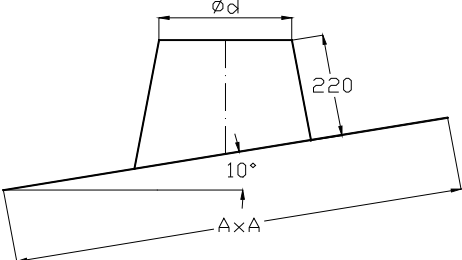
Prostup střechou		DN mm	80	100	130	150	180	200
	kg/kus	9,290	9,290	9,640	9,640	10,300	10,300	
	$\varnothing d$ (mm)	165	165	215	215	265	265	
	DN mm	230	250	300	350	400		
	kg/kus	10,550	12,820	12,630	15,330	15,000		
	$\varnothing d$ (mm)	295	320	370	415	425		

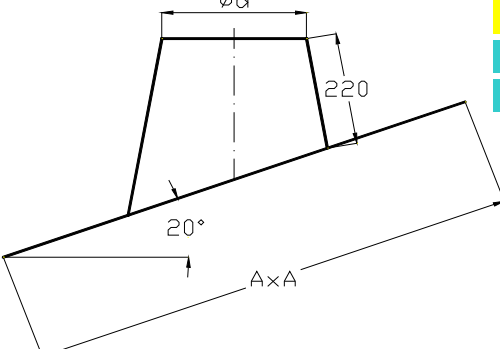
Prostup střechou		DN mm	80	100	130	150	180	200
	kg/kus	9,180	9,180	9,440	9,440	10,850	10,850	
	$\varnothing d$ (mm)	165	165	215	215	265	265	
	DN mm	230	250	300	350	400		
	kg/kus	11,720	13,460	13,960	15,670	15,000		
	$\varnothing d$ (mm)	295	320	370	415	425		

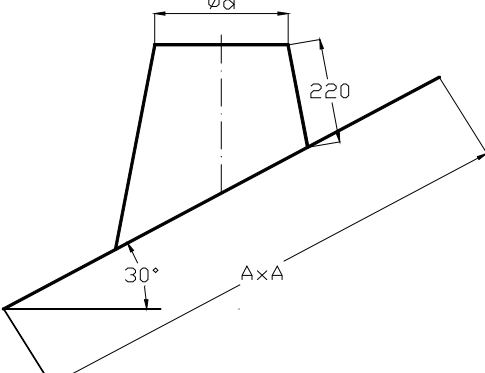
Prostup střechou		DN mm	80	100	130	150	180	200
	kg/kus	9,060	9,060	9,240	9,240	11,390	11,390	
	$\varnothing d$ (mm)	165	165	215	215	265	265	
	DN mm	230	250	300	350	400		
	kg/kus	12,880	14,100	15,290	16,000	15,000		
	$\varnothing d$ (mm)	295	320	370	415	425		

### Prostup střechou

36° - 45°

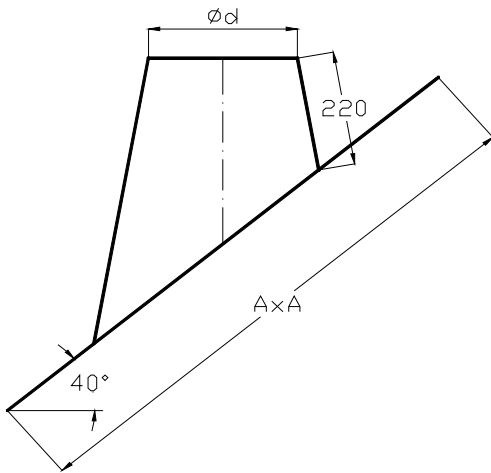

DN mm	80	100	130	150	180	200
kg/kus	10,150	10,150	10,350	10,350	12,760	12,760
Ø d (mm)	165	165	215	215	265	265
DN mm	230	250	300	350	400	
kg/kus	14,430	15,790	17,120	17,920	16,800	
Ø d (mm)	295	320	370	415	425	

### Patní konzola

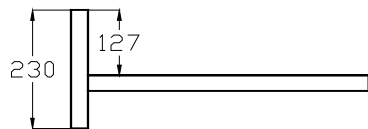

DN mm	80	100	130	150	180	200
min odstup	90	90	90	90	90	-
max. odstup	200	200	200	200	200	-
DN mm	230	250	300	350	400	
min odstup	-	-	-	-	-	-
max. odstup	-	-	-	-	-	-

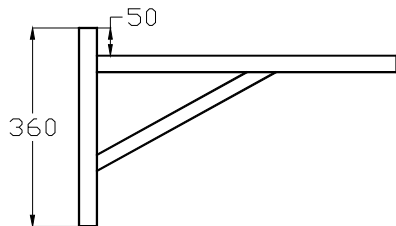

min odstup	235	215	185	165	135	115
max. odstup	320	300	270	250	220	200
min odstup		90	-	-	-	-
max. odstup		150	-	-	-	-

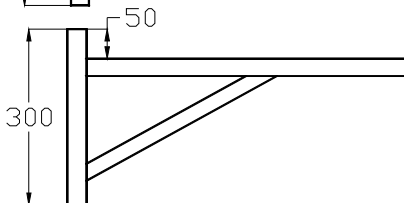

min odstup	270	250	220	200	170	150
max. odstup	435	415	385	365	335	315
min odstup		100	90	90	-	-
max. odstup		265	210	160	-	-

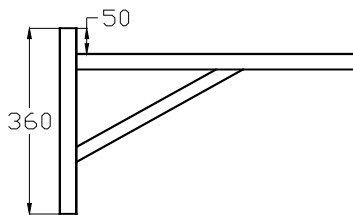

min odstup	435	415	385	365	335	315
max. odstup	735	715	685	665	635	615
min odstup		265	210	160	110	-
max. odstup		565	510	460	410	-

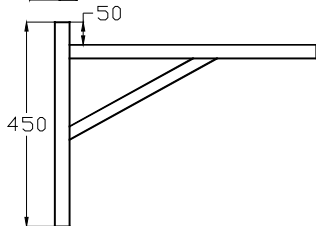

min odstup	-	-	-	-	-	-
max. odstup	-	-	-	-	-	-
min odstup		-	510	460	410	-
max. odstup		-	600	600	600	-

<b>Prodlužovací</b>	<b>DN mm</b>	<b>80</b>	<b>100</b>	<b>130</b>	<b>150</b>	<b>180</b>	<b>200</b>
---------------------	--------------	-----------	------------	------------	------------	------------	------------

nástěnná konzola	max. odstup	100	100	100	100	100	-
------------------	-------------	-----	-----	-----	-----	-----	---

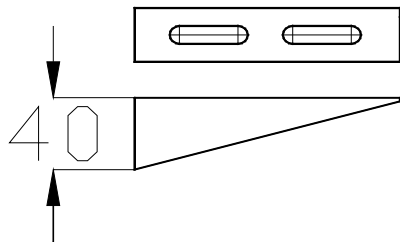

<b>DN mm</b>	<b>230</b>	<b>250</b>	<b>300</b>	<b>350</b>	<b>400</b>
max. odstup	-	-	-	-	-

max. odstup	-	-	-	-	-	100
-------------	---	---	---	---	---	-----

max. odstup	-	-	-	-	-	-
-------------	---	---	---	---	---	---

max. odstup	250	250	250	250	250	-
-------------	-----	-----	-----	-----	-----	---

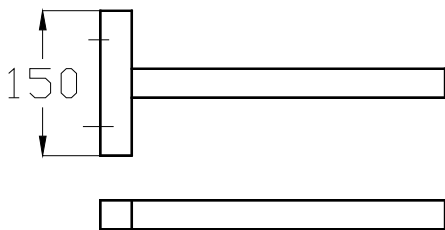

max. odstup	400	400	400	400	400	250
-------------	-----	-----	-----	-----	-----	-----

max. odstup	-	-	-	-	-	400
-------------	---	---	---	---	---	-----

max. odstup	-	-	-	-	-	-
-------------	---	---	---	---	---	---

max. odstup	600	600	600	600	600	600
-------------	-----	-----	-----	-----	-----	-----

max. odstup	-	-	-	-	-	-
-------------	---	---	---	---	---	---

<b>Přestavitelné lůžko</b>	<b>DN mm</b>	<b>80</b>	<b>100</b>	<b>130</b>	<b>150</b>	<b>180</b>	<b>200</b>
----------------------------	--------------	-----------	------------	------------	------------	------------	------------

na konzoli	kg/kus	0,440	0,480	0,530	0,580	0,640	0,700
------------	--------	-------	-------	-------	-------	-------	-------

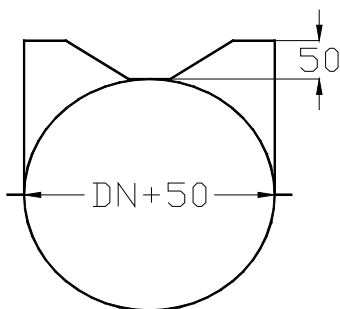

<b>DN mm</b>	<b>230</b>	<b>250</b>	<b>300</b>	<b>350</b>	<b>400</b>
kg/kus	0,790	1,180	3,300	3,650	4,030

<b>Pevné lůžko</b>	<b>DN mm</b>	<b>80</b>	<b>100</b>	<b>130</b>	<b>150</b>	<b>180</b>	<b>200</b>
--------------------	--------------	-----------	------------	------------	------------	------------	------------

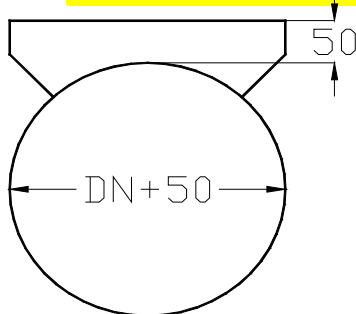

kg/kus	0,44	0,48	0,53	0,58	0,64	0,70
--------	------	------	------	------	------	------

<b>DN mm</b>	<b>230</b>	<b>250</b>	<b>300</b>	<b>350</b>	<b>400</b>
kg/kus	0,79	1,30	2,88	3,24	3,61